

## ParaLED LDHT-xxx-7846-Series Datasheet

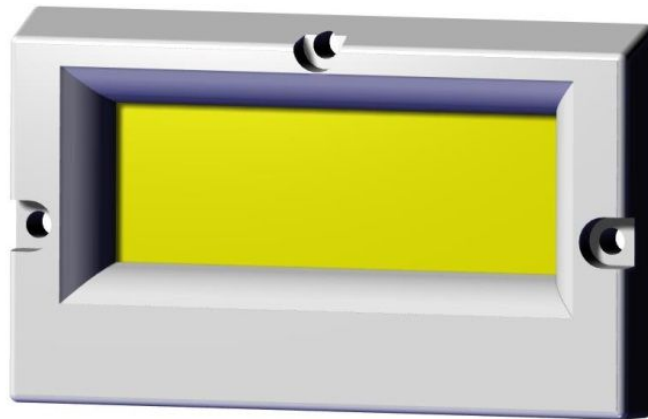

### Introduction :

Compared with DC LED modules, ParagonLED AC COB(Driver on Board)ParaLED® Series module does not need an external driver so that it is able to enhance lifespan and shows compact dimension.

### Description :

- 120/277/347/480VAC
- 35W
- 115-125 LM/W
- 5000 CCT
- 70 CRI
- PF>0.98
- THDi < 20%
- IP67 Waterproof

### Feature and Benefits:

- Driver on Board
- Industry grade solid state components
- Up to 2KV Surge protection built-in
- Lifespan>50K hrs TC<105°C
- Lowest thermal resistance



## Table of Contents

---

General Information.....	3
Characteristics.....	4
Luminous Flux Characteristic.....	5
Mechanical Dimensions.....	6
Characteristic curve.....	7
Layout .....	9
Reliability.....	10
Installation Manual AC.....	11
Assembly Notes.....	12
About ParagonLED.....	13



## General Information

---

### Ordering Code Format

L D HT - xxx - 7846 - yyyV - zz  
1 2 3 4 5 6 7  
120V  
277V  
347V  
480V

- 1 . Model type
- 2 . Chip efficacy
- 3 . Driving condition
- 4 . Numbers of chips
- 5 . Outline dimension (The LED module, including the protective ring)
- 6 . Forward voltage (AC)
- 7 . Correlated color temperature (K)



## Characteristics

Parameter	Symbol	Value		Unit
Forward Voltage	V <sub>F</sub>	120/277	347/480	VAC
Forward Voltage	V <sub>F</sub>	±10%	±5%	VAC
Operation Frequency	F <sub>op</sub>	50/60		Hz
Power Dissipation	P <sub>D</sub>	35		W
Operating Temperature	T <sub>op</sub>	-40 ~ +105		°C
Storage Temperature	T <sub>st</sub>	-40 ~ +105		°C
Surges Protection(L/N)	V <sub>s</sub>	2		KV
Insulation voltage	Viso[RMS]	120V:1240 / 277V:1554 347V:1694 / 480V:1960		VAC
Power Factor	PF	>0.98		
THDi		<20		%
Color coordination	ANSI C78.377:2008	IEC 60081:1997		

ANSI CCT	step*	C <sub>x</sub>	C <sub>y</sub>
2700K	3	0.458	0.410
3000K	3	0.434	0.403
3500K	3	0.407	0.392
4000K	3	0.382	0.380
4500k	3	0.361	0.366
5000K	3	0.345	0.355
5700k	5	0.329	0.342
6500K	5	0.312	0.328

\*Color region stay within MacAdam ellipse from the chromaticity center.

IEC CCT	step*	C <sub>x</sub>	C <sub>y</sub>
2700K	3	0.463	0.420
3000K	3	0.440	0.403
3500K	3	0.409	0.394
4000K	3	0.380	0.380
5000K	3	0.346	0.359
6500K	5	0.313	0.337

\* Color region stay within MacAdam ellipse from the chromaticity center.



## Luminous Flux Characteristic

Product No	Forward Voltage	Watt	lm/W	Lumen	Color rendering	Color Temperature
LDHT-384-7846-120V-50	120V	35	115	4025	70	5000
LDHT-315-7846-277V-50	277V	35	120	4200	70	5000
LDHT-408-7846-347V-50	347V	35	125	4375	70	5000
LDHT-384-7846-480V-50	480V	35	130	4550	70	5000



## Mechanical Dimensions

---

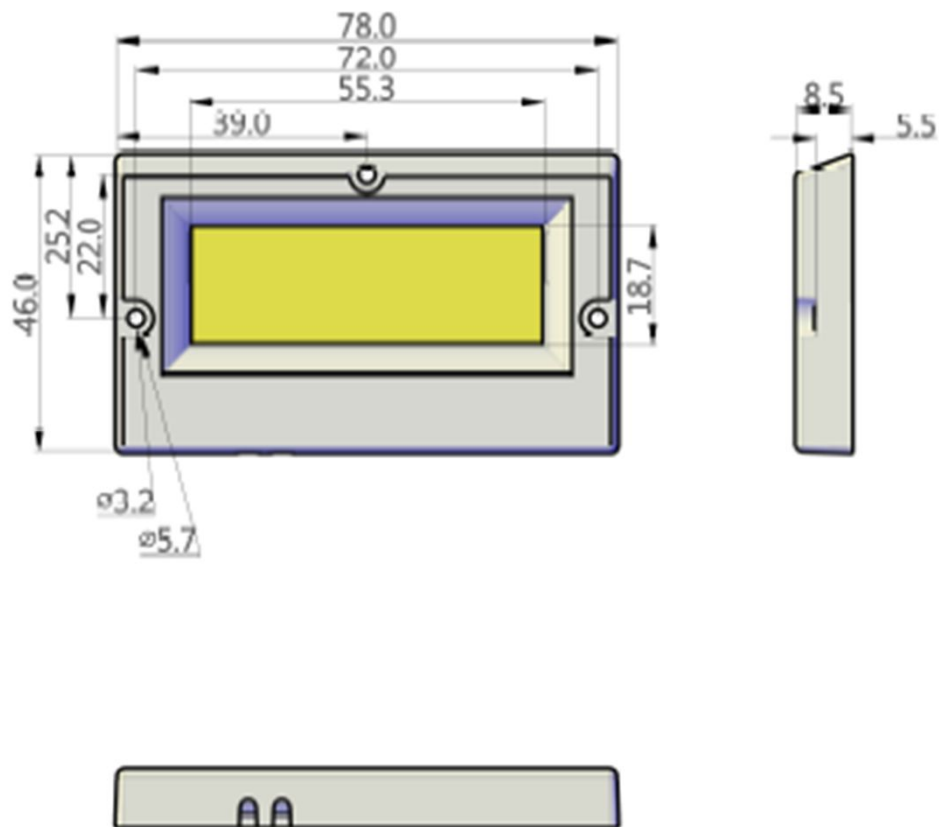

1. All dimensions are measured in mm.
2. Tolerance :  $\pm 0.2\text{mm}$



## Characteristic curve

### Color Spectrum

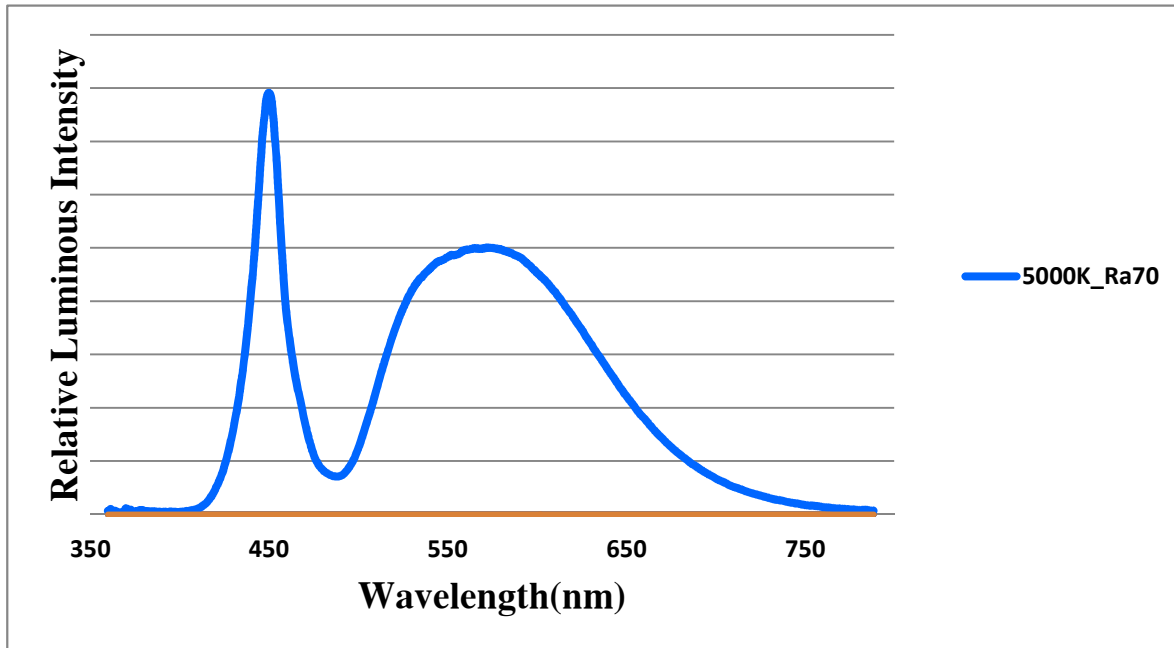

### Beam Pattern

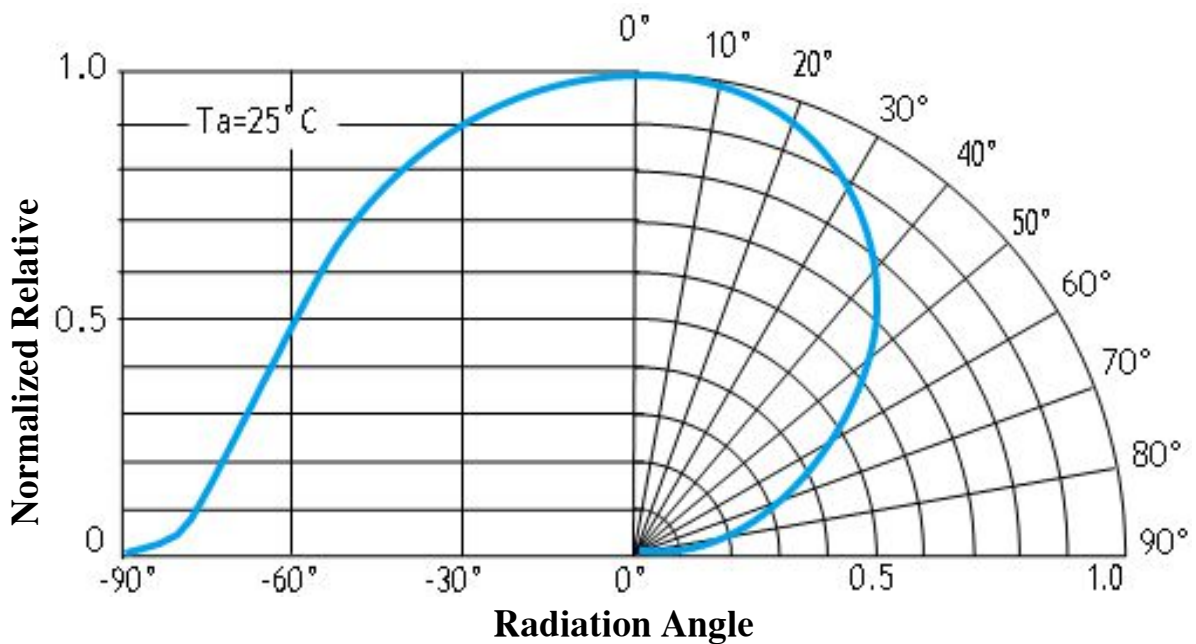

## Characteristic curve

### Power Dissipation vs. Voltage

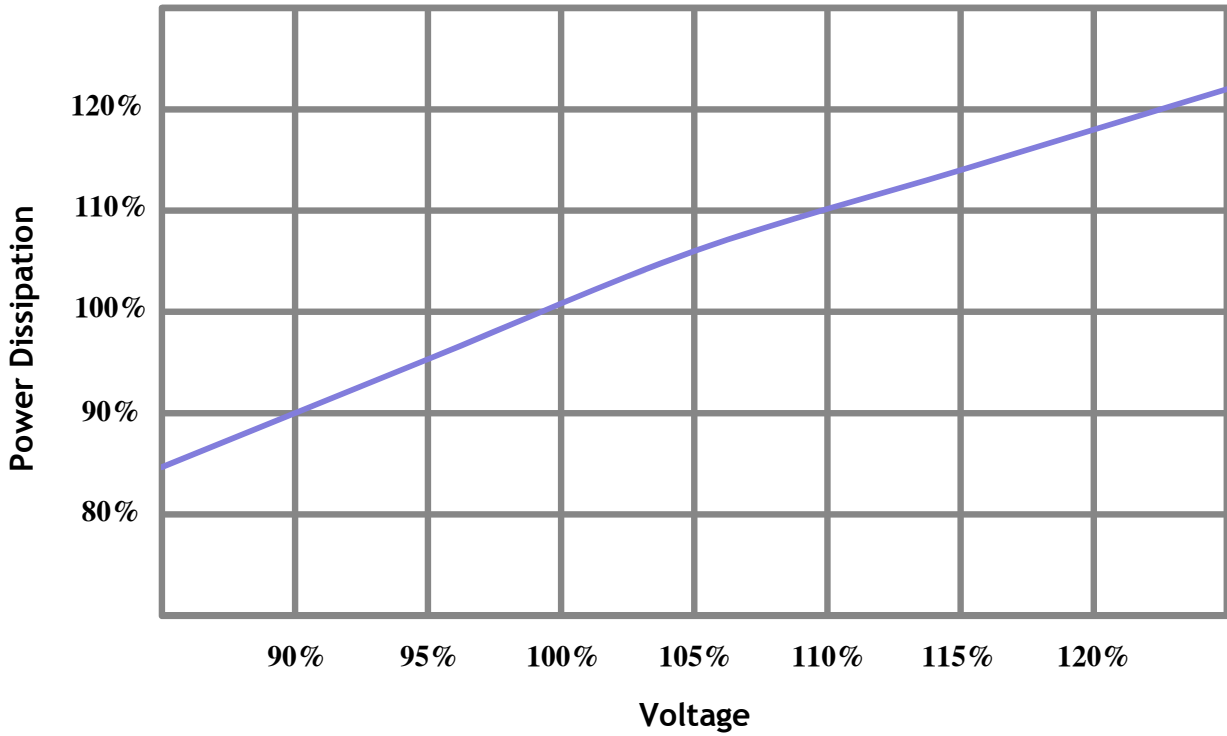

### Relative Luminous Flux vs. Voltage

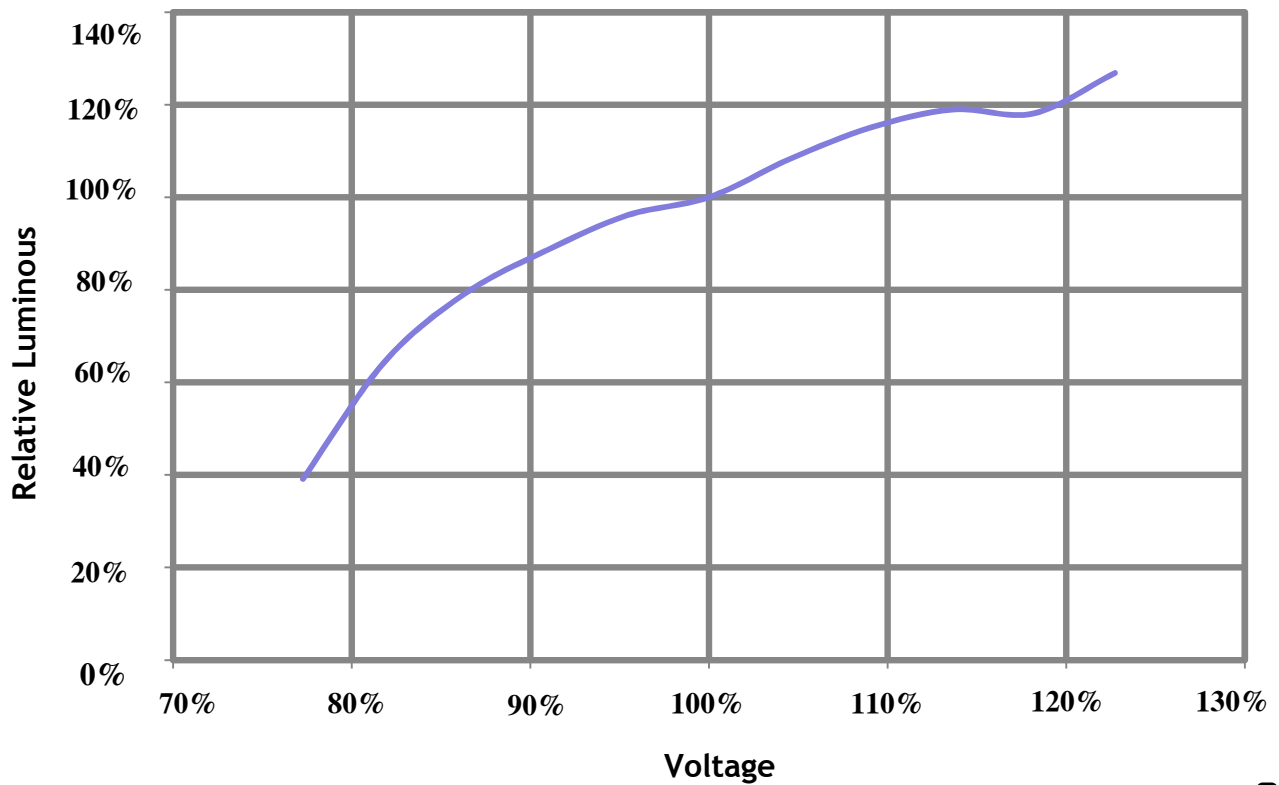



## Layout

---

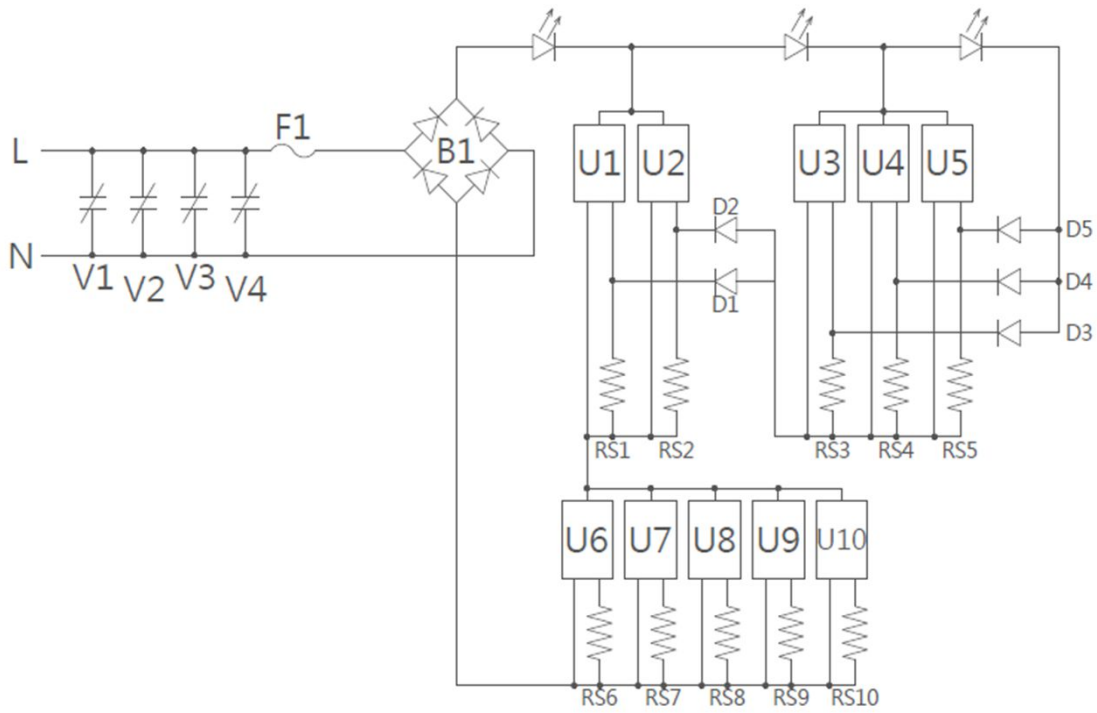

## Reliability

No.	Test Item	Test Condition	Remark
1	Temperature Cycle	-40°C~100°C ( 30 mins / 30 mins )	100 Cycle
2	Low-Temperature Storage	Ta= -40°C	1000 hrs
3	High-Temperature Storage	Ta=105°C	1000 hrs
4	High Temperature High Humidity Life test	Ta=85°C, RH=85%	500 hrs
5	High Temperature Operation Life test	Tc = 55°C / 85°C / 105°C	6000 hrs
6	ON/OFF Test	3 sec ON, 3 sec OFF	2Million times

Ta : Temperature Ambient

RH : Relative Humidity

Tc Point

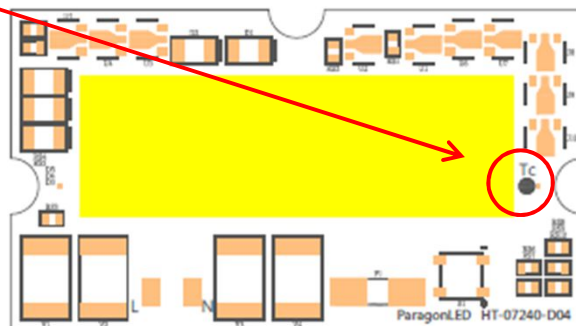

## Installation Manual AC

---

### Preparation

First, please make sure all surface on installation area is clean for better COB bottom connection.

### Installation

1. To make sure fixture connecting side of surface of heat sink is flat, smooth & clean.
2. Peel off paper from thermal pad, place module onto the fixture and please refer to Figure 1.

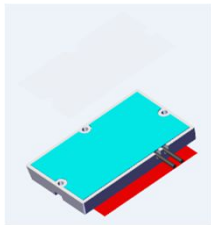

3. Fix the module by using M3 screws. When clamping, the torque is around 0.4 Nm, please refer to Figure 2.

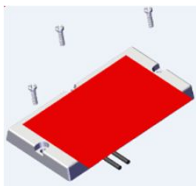

4. Before light-on, remove the red tape on LES, please refer to Figure 3.

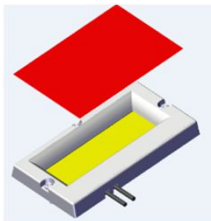

### Temperature

The rear side of LED light module shall not exceed 105°C after lighting up for at least one hour.

### L.N connection

Please refer to Figure 4.

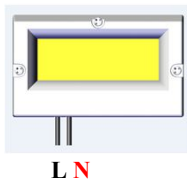

## Assembly Notes

---

### Correct

Recommended to use antistatic gloves

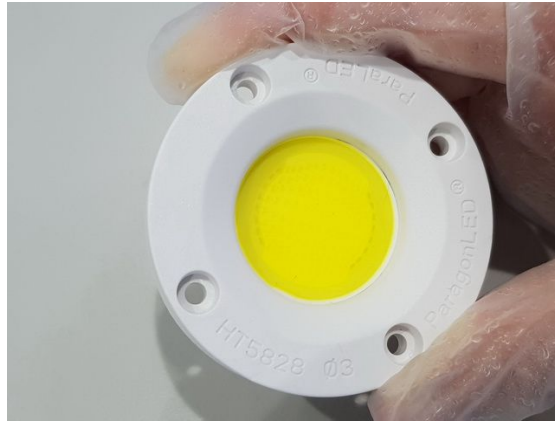

### Wrong

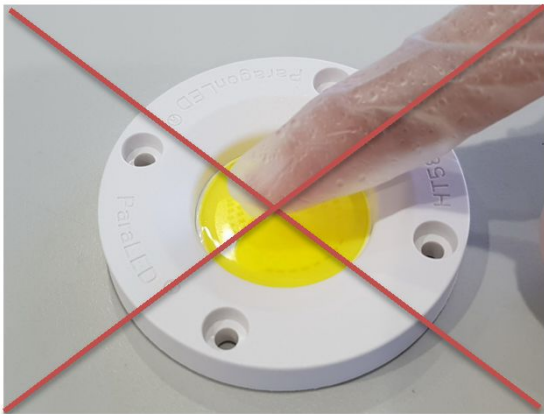

Do not touch the emitting area

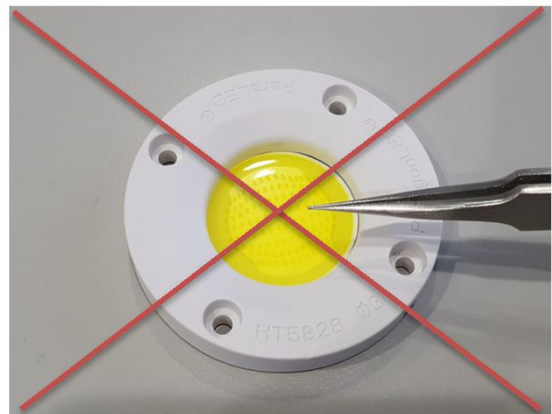

Do not touch the emitting area



## About ParagonLED

---

Established in 2008, Paragon Semiconductor Lighting Technology Co., Ltd. (ParagonLED®) has been devoted to be a comprehensive supplier of COB LED products. Our product lines include 1.AC LED module 2.Thermal management integration 3.Optical integration 4.AI integration 5.Constant power module series. We have been addressed ourselves to provide good quality products to satisfy clients' needs. Meanwhile we are not in a standstill situation, but keep pursuing progression and innovation.

ParagonLED® pride ourselves on our products, so we have overall arrangement in patent; the total applied patents have been reached 135 items until now. Our manufacturing techniques are also patented by many countries, and we still keep moving forward. Meanwhile we supply good quality products with good performance on CRI and efficiency (lm/w), and strictly controlled CCT.

In ParagonLED®, we do not only supply products, but also provide technical recommendations. What's more, we are more than willing to solve problems with clients together. Hence ParagonLED® and our clients can work together to supply reliable and qualified products to end users!

Devote ourselves to bring more added-value to clients

- →Direct Marketing + Localized operation

We have offices in Taiwan, in DongGuan, China, so that we can deal with enquiries directly. Also with agents in many different countries, we and they are able to take care of clients on local basis.

- → Fast delivery

With the manufacturing site located in New Taipei City Linkou, Taiwan, we have different yet convenient transportation ways to reach the world.

- Customized service

Through professional and experienced research and development techniques, we provide customized products that can be tailored to different requirements.

