

*Paragon Semiconductor Lighting Technology*

*PSLT*

**ParagonLED**

## Specifications

**Product Type : CBLC-42-30135-120V-30**

**Issued Date : 10/10/2016**

Paragon Semiconductor Lighting Technology Co., Ltd.  
Headquarters: 3F., No.369, Sec. 2, Wenhua 2nd Rd., Linkou Dist., New Taipei City 244, Taiwan (R.O.C.)  
TEL: +886-2-2602-1066      FAX: 886-2-2601-0508

# Contents

## 1. General Description

1-1 Naming Rule

1-2 Outline dimensions

## 2. Electro-optical characteristics

2-1 Absolute Maximum Rating

2-2 Electro-optical characteristics

2-3 Graphs

2-4 Layout

## 3. Junction Temperature measurement

## 4. Reliability Test

# 1. General Description

## (1) Naming rule

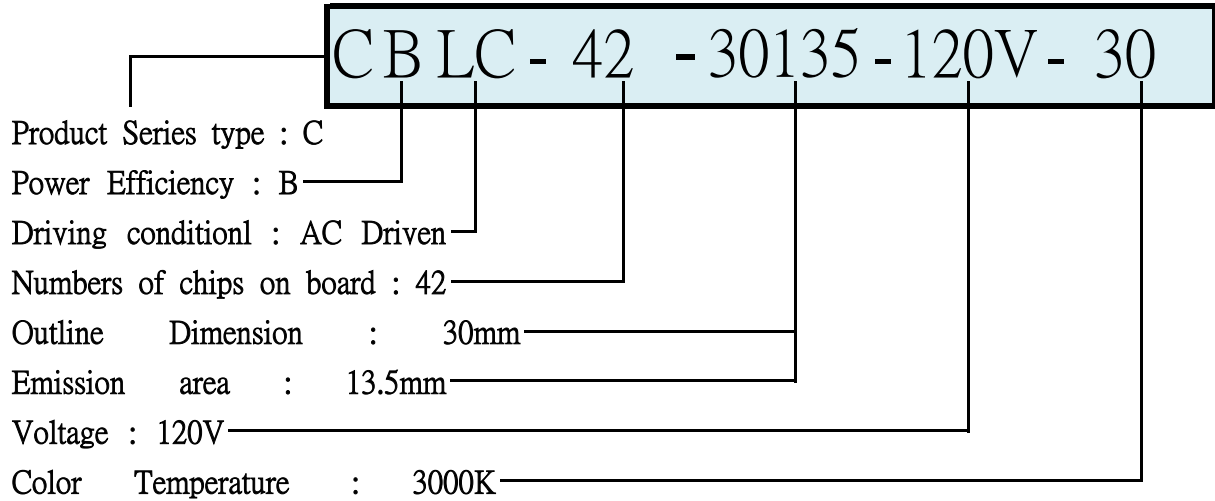

## (2) Outline Dimensions (Unit : mm / Tolerance: 0.2mm)

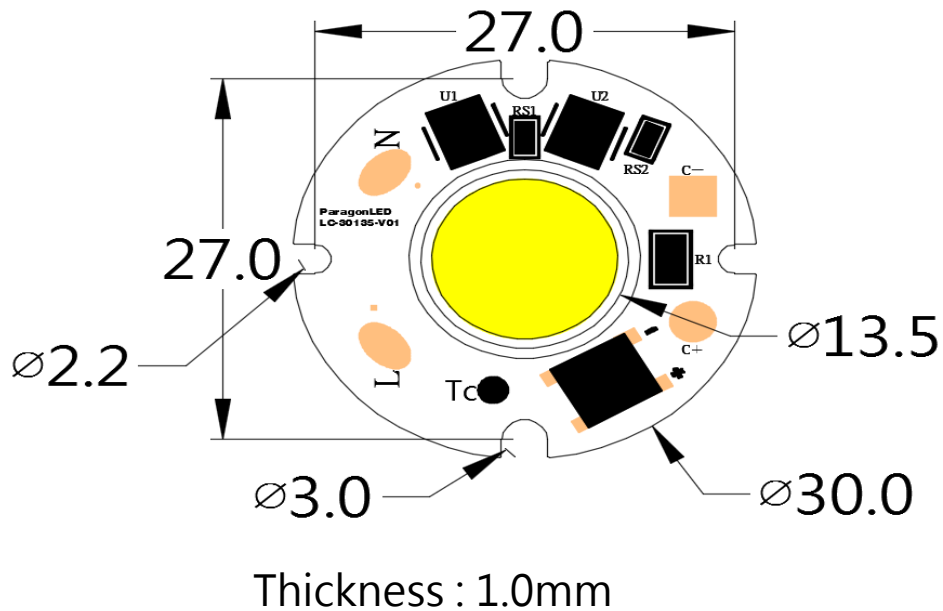

# 2. Electro-Optical Characteristics

## (1) Absolute Maximum Rating

Parameter	Symbol	Value	Unit
Power Dissipation	PD	11	W
Forward Current	IF	-	mA
Forward Voltage	VF	110 ~ 140	V
Operating Temperature	Topr	-60 ~ +105	°C
Storage Temperature	Tstg	-60 ~ +105	°C
Assembly process temperature	Tsol	<300°C , 5 secs	

## (2) Electro-Optical Characteristics

Parameter	Symbol	Condition	Min	Typ	Max	Unit
Forward Voltage	VF	-	110	120	140	V
Percent Flicker		-	-	-	30	%
Luminous Intensity	$\Phi_v$	VF=120V	-	792	-	Lm
Color rendering	Ra	VF=120V	90	-	-	

**Notice: Operating voltage of CBLC-042 product varies from 110V~140V · users must keep the temperature of solder joint point under 105°C (with suitable heat sink), or may cause Serious luminous decay. We DO NOT guarantee of improper use.**

## (3) Characteristics

### Spectrum

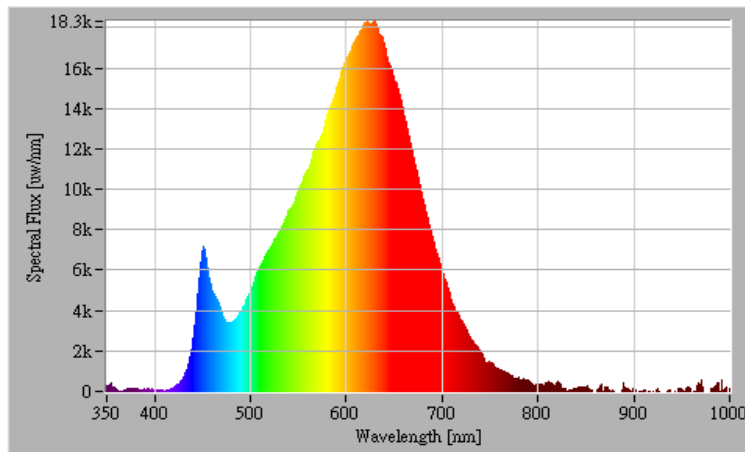

### Candle Power Distribution & Cartesian Coordinate

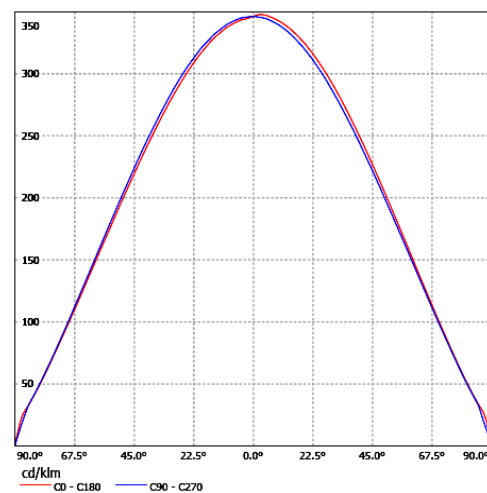
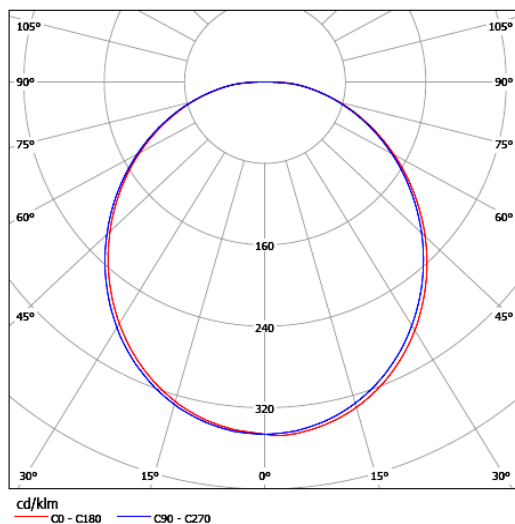

#### (4) Layout

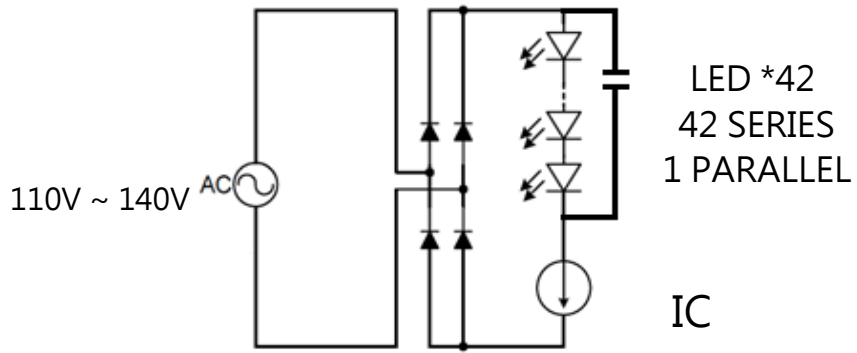

### 3. Junction Temperature Measurement

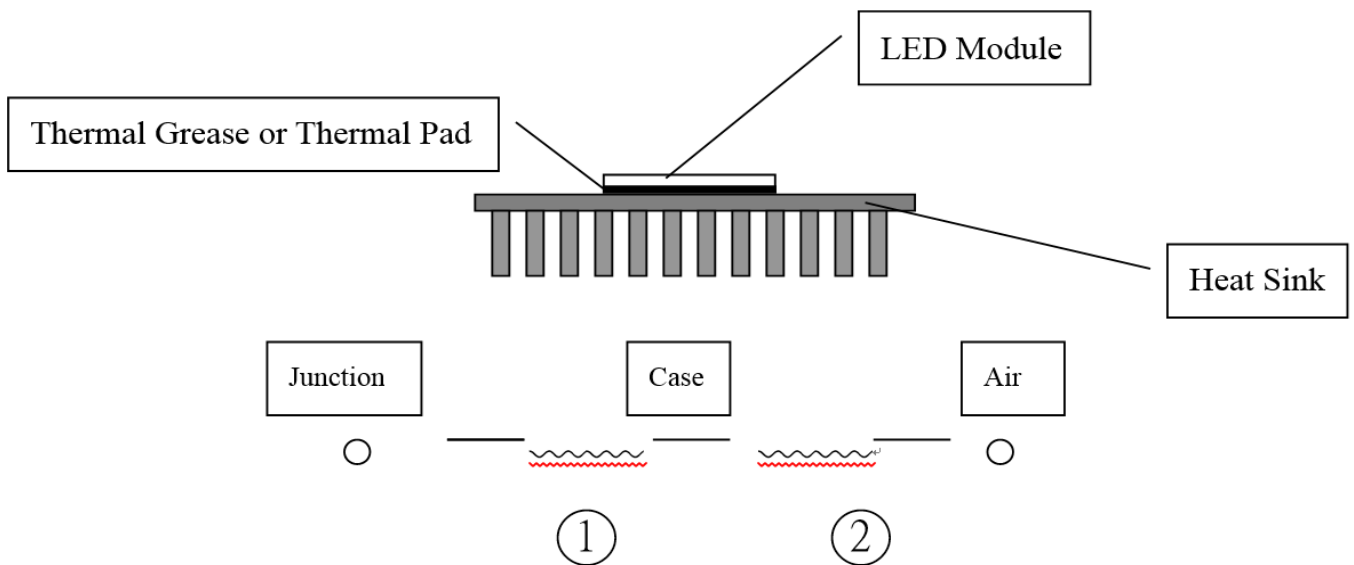

- ① Thermal resistance of Junction to Case without heat sink :  $10(^{\circ}\text{C}/\text{W})$  [ Reference Value ]
- ② Thermal resistance of Case to Ambient Air: Depending on what kind of heat sink users choose. In ideal thermal dissipation situation, the thermal resistance is about  $1\sim 2^{\circ}\text{C}/\text{W}$ .

## 4. Reliability Test

Test Item	Test Conditions	Number of failed
High Temperature Storage Test	Tstg= +105°C , x1,000 hrs	0/20
Low Temperature Storage Test	Tstg=-40°C , x1,000 hrs	0/20
Continous Light-on Test	Ta= 25°C , RH=65% , x1,000 hrs	0/20
Boiling Test	Ta=100°C , RH=100% , X180mins	0/20
Thermal Cycle Test	- 40°Cx30mins , 80°Cx30mins , 100cycles	0/20

Measuring Item	Measuring Condition	Judging Criteria of Failure
Forward Voltage	VF=120V	> 0 x 1.1
Total Luminous Flux	VF=120V	< L x 0.85

***Dielectric Breakdown Voltage (Vac) of Thermal Pad must >4 KV***

***WARNING : Please ground lighting fixtures while designing lamps.  
If any damage or defect of LED caused without grounding, we do not guarantee of improper use.***