

ParaLED L-type(45mm) Socket Datasheet



ParagonLED®

Introduction :

Compared with DC LED modules, ParagonLED AC COB(Driver on Board)ParaLED® Series module does not need an external driver so that it is able to enhance lifespan and shows compact dimension.

Description :

- 120/230VAC
- 10/12 W
- 70-90 LM/W
- 2700/3000 CCT
- 90 CRI
- PF>0.98
- THDi < 20%
- Customized available

Feature and Benefits:

- Driver on Board
- Industry grade solid state components
- 0.5KV Surge protection built-in
- Lifespan>50K hrs TC<105°C
- Lowest thermal resistance



Table of Contents

General Information.....	3
Characteristics.....	4
Luminous Flux Characteristic.....	5
Mechanical Dimensions.....	6
Characteristic curve.....	9
Reliability.....	11
Accessory.....	12
About ParagonLED.....	13



General Information

Ordering Code Format

ParaLED- A- □□□ - □□□ V □□ W - □□□□□ - □ □

1 2 3 4 5 6 7 8 9

- 1 . Product series type
- 2 . Dimming Type : Dimming
- 3 . Numbers of chips
- 4 . Forward voltage (AC)
- 5 . Wattage (W)
- 6 . Correlated color temperature (K)
- 7 . Color rendering
- 8 . Appearance : Fixing Iron piece, code numbers reference to page.6~7
- 9 . Optical parts : Light Guide Lens, code numbers reference to page.6~7



Characteristics

Parameter	Symbol	Value	Unit
Forward Voltage	V _F	120/230	VAC
Forward Voltage range	V _F	±10%	VAC
Operation Frequency	F _{op}	50/60	Hz
Power Dissipation	P _D	10/12	W
Ambient Temperature	T _{op}	-40 ~ +45	°C
Storage Temperature	T _{st}	-40 ~ +105	°C
Surges Protection(L/N)	V _s	0.5	KV
Insulation voltage	Viso[RMS]	120V:1240 / 230V:1460	VAC
Power Factor	PF	>0.98	
THDi		<20	%
Color coordination	ANSI C78.377:2008	IEC 60081:1997	

ANSI CCT	step*	Cx	Cy
2700K	3	0.458	0.410
3000K	3	0.434	0.403
3500K	3	0.407	0.392
4000K	3	0.382	0.380
4500k	3	0.361	0.366
5000K	3	0.345	0.355
5700k	5	0.329	0.342
6500K	5	0.312	0.328

*Color region stay within MacAdam ellipse from the chromaticity center.

IEC CCT	step*	Cx	Cy
2700K	3	0.463	0.42
3000K	3	0.440	0.403
3500K	3	0.409	0.394
4000K	3	0.380	0.38
5000K	3	0.346	0.359
6500K	5	0.313	0.337

* Color region stay within MacAdam ellipse from the chromaticity center.



Luminous Flux Characteristic

Product No	Forward Voltage	Watt	lm/W	Lumen	Color rendering	Color Temperature
ParaLED-A-042-120V10W2700A	120V	10	70	700	90	2700
ParaLED-A-042-120V10W3000A	120V	10	70	700	90	3000
ParaLED-A-042-120V10W3020A	120V	10	70	700	90	3020
ParaLED-A-042-120V12W2700A	120V	12	70	840	90	2700
ParaLED-A-042-120V12W3000A	120V	12	70	840	90	3000
ParaLED-A-042-120V12W3020A	120V	12	70	840	90	3020
ParaLED-A-042-230V10W2700A	230V	10	70	700	90	2700
ParaLED-A-042-230V10W3000A	230V	10	70	700	90	3000
ParaLED-A-042-230V10W3020A	230V	10	70	700	90	3020
ParaLED-A-042-230V12W2700A	230V	12	70	840	90	2700
ParaLED-A-042-230V12W3000A	230V	12	70	840	90	3000
ParaLED-A-042-230V12W3020A	230V	12	70	840	90	3020

Note: Color Temperature 3020: dim to warm 3000~2000K



Mechanical Dimensions

Base Type :Conduction Body(45mm)+Bulb(HA)

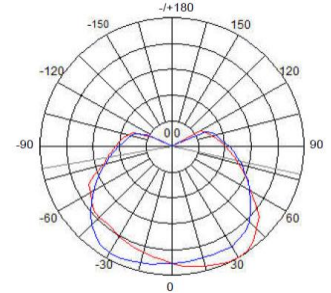
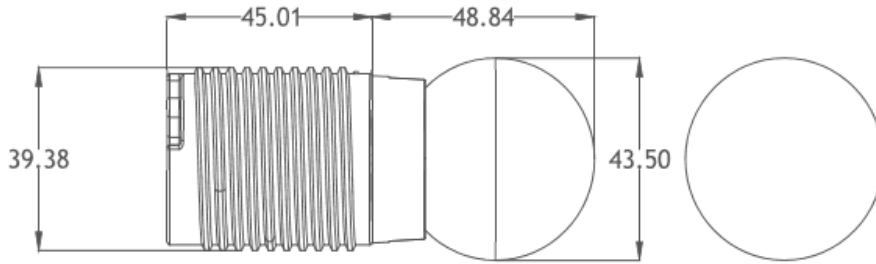

Base Type :Conduction Body(45mm)+Light guide column(HB)

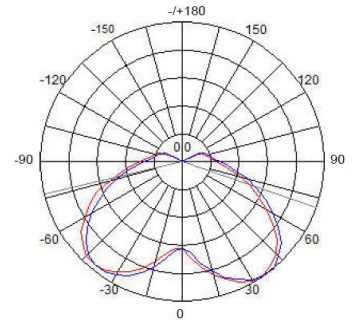
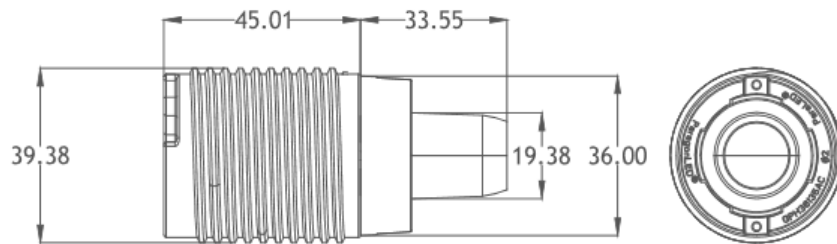

Base Type Conduction Body(45mm)+24° Lens(HC)
Conduction Body(45mm)+38° Lens(HD)

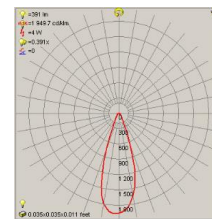
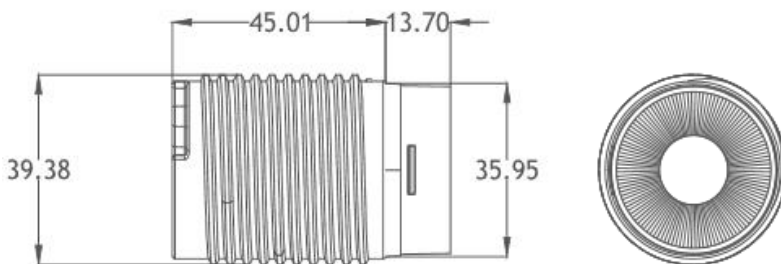

INTENSITY 38°

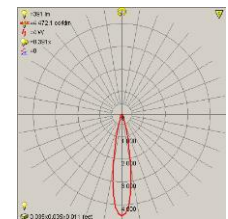

INTENSITY 24°

Base Type :Base Type :Conduction Body(45mm)+12° Lens(HE)

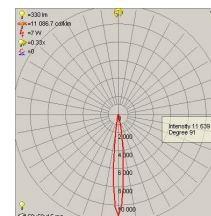
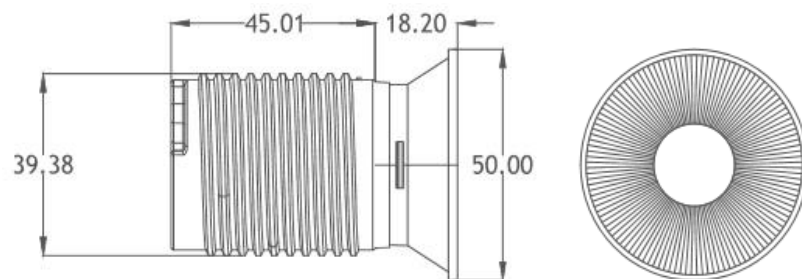

INTENSITY 12°

Base Type :Conduction Body(45mm)(HX)

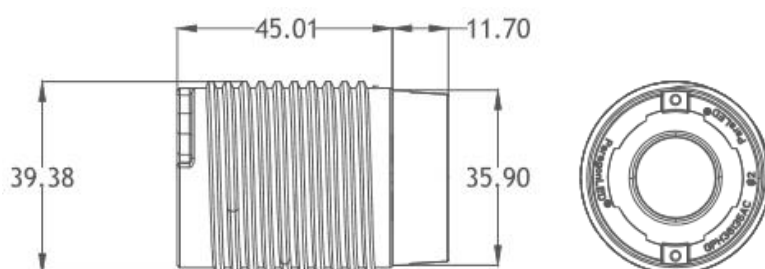

Mechanical Dimensions

Base Type :Conduction Body(45mm)+Bulb+Fixer(BA)

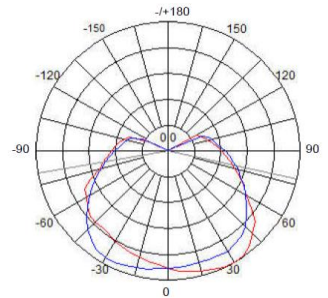
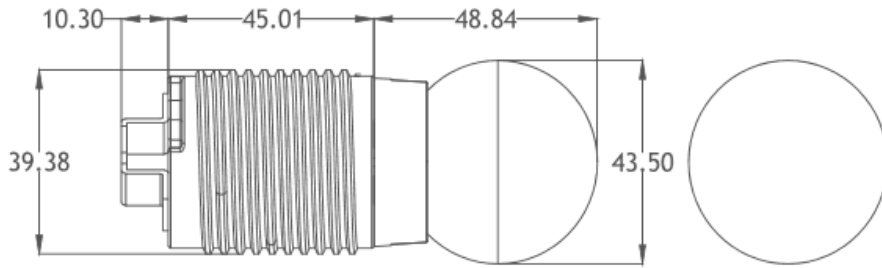

Base Type :Conduction Body(45mm)+Light guide column+Fixer(BB)

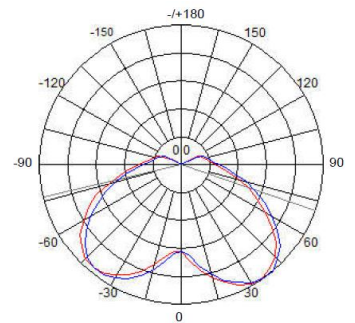
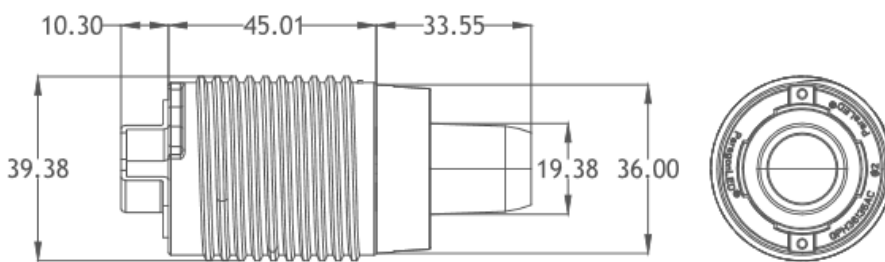

Base Type Conduction Body(45mm)+24° Lens+Fixer(BC)
Conduction Body(45mm)+38° Lens+Fixer(BD)

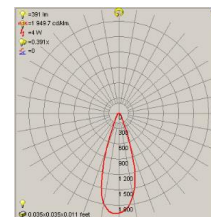
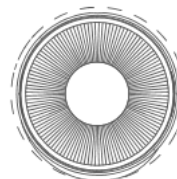
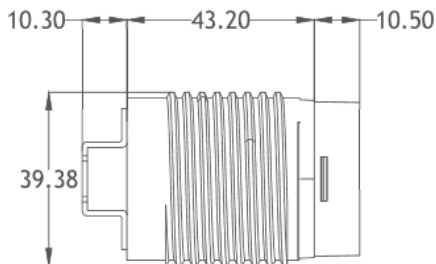

INTENSITY 38°

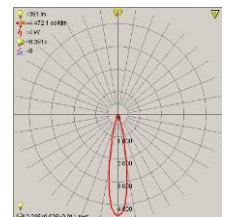

INTENSITY 24°

Base Type :Base Type :Conduction Body(45mm)+12° Lens+Fixer(BE)

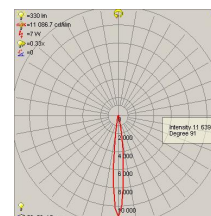
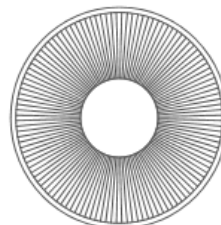
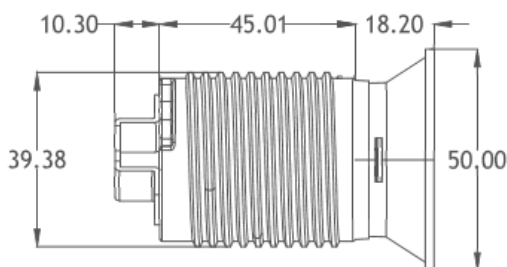

INTENSITY 12°

Base Type :Conduction Body(45mm)+Fixer(BX)

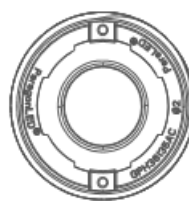
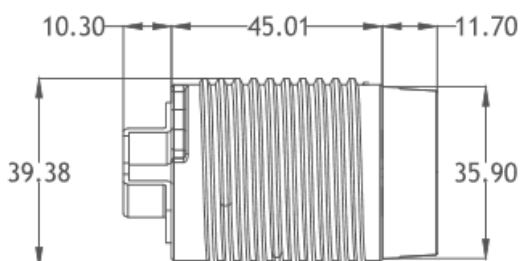

Mechanical Dimensions

Base Type :Conduction Body(45mm)+Bulb+GU24(FA)

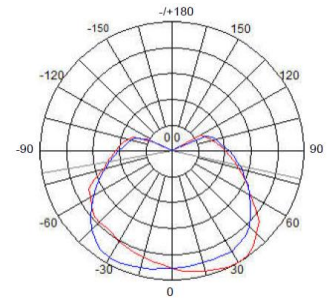
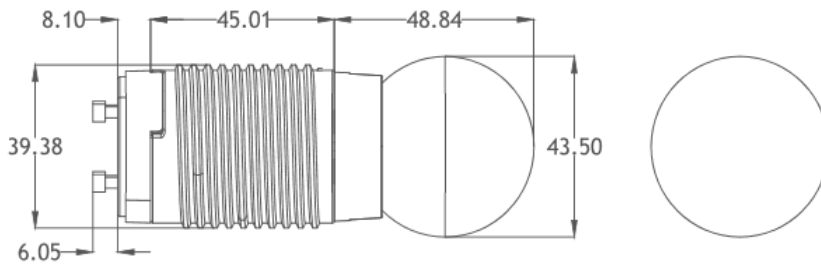

Base Type :Conduction Body(45mm)+Light guide column+GU24(FB)

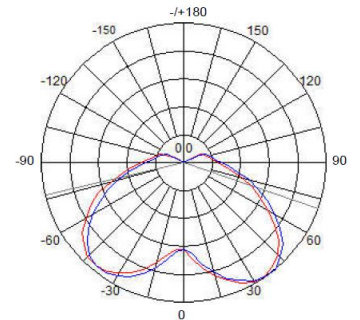
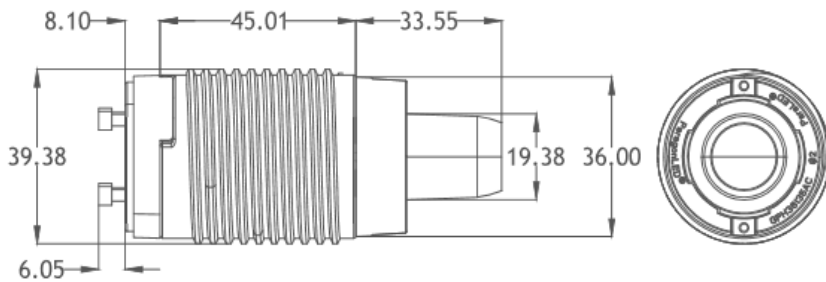

Base Type Conduction Body(45mm)+24° Lens+Fixer+GU24(FC)
Conduction Body(45mm)+38° Lens+Fixer+GU24(FD)

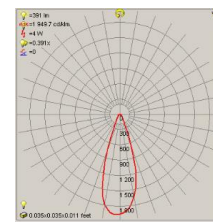
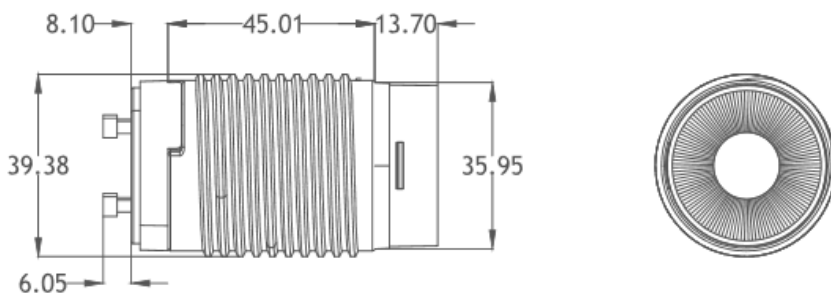

INTENSITY 38°

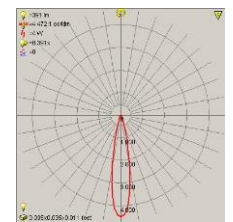

INTENSITY 24°

Base Type :Base Type :Conduction Body(45mm)+12° Lens+GU24(FE)

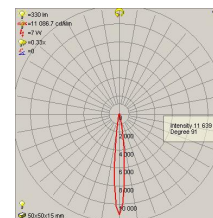
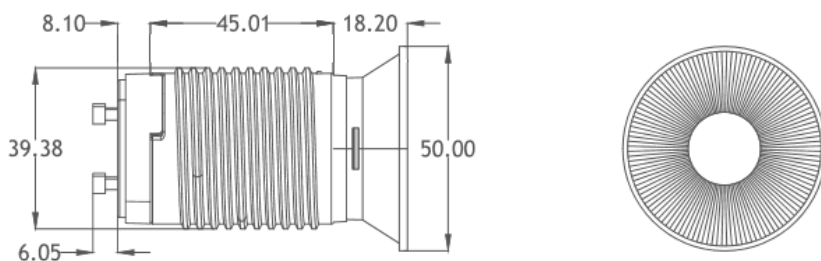

INTENSITY 12°

Base Type :Conduction Body(45mm)+GU24(FX)

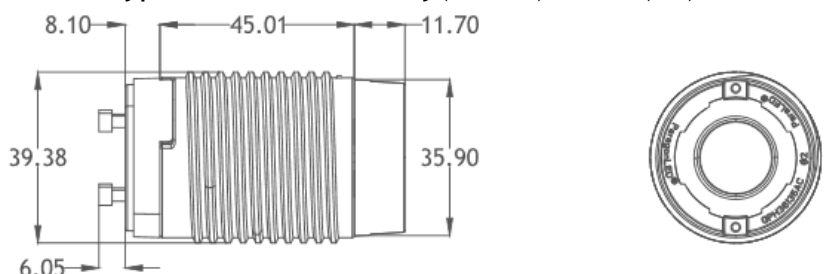

Characteristic curve

Color Spectrum

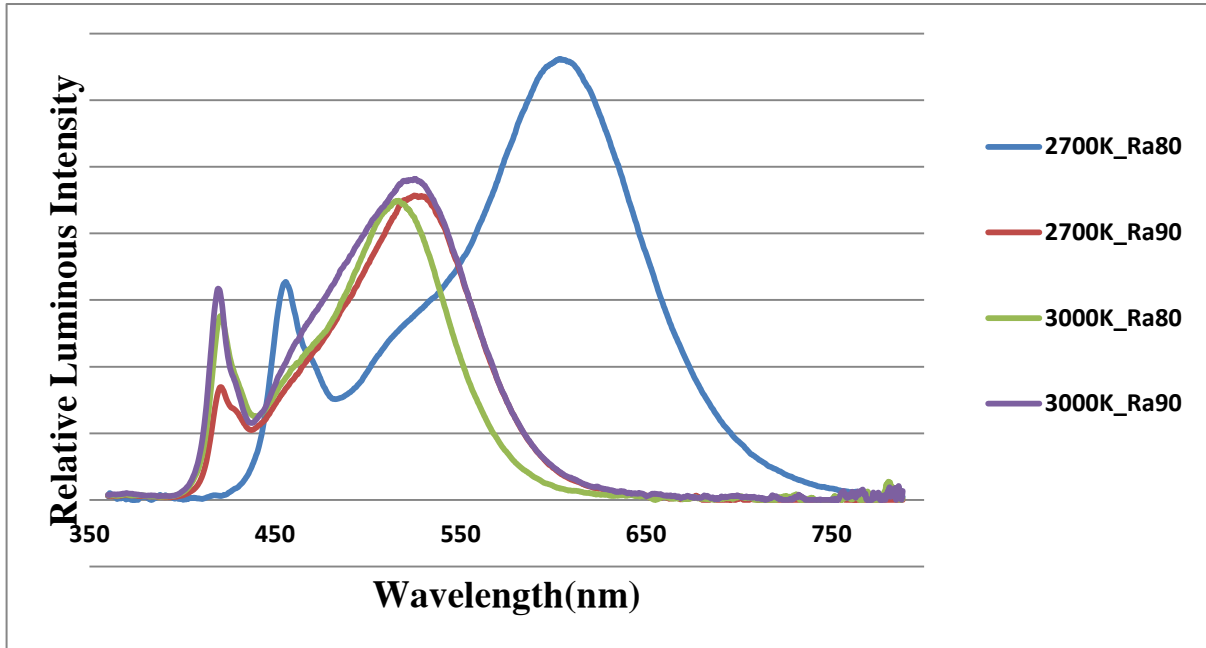

Characteristic curve

Power Dissipation vs. Voltage

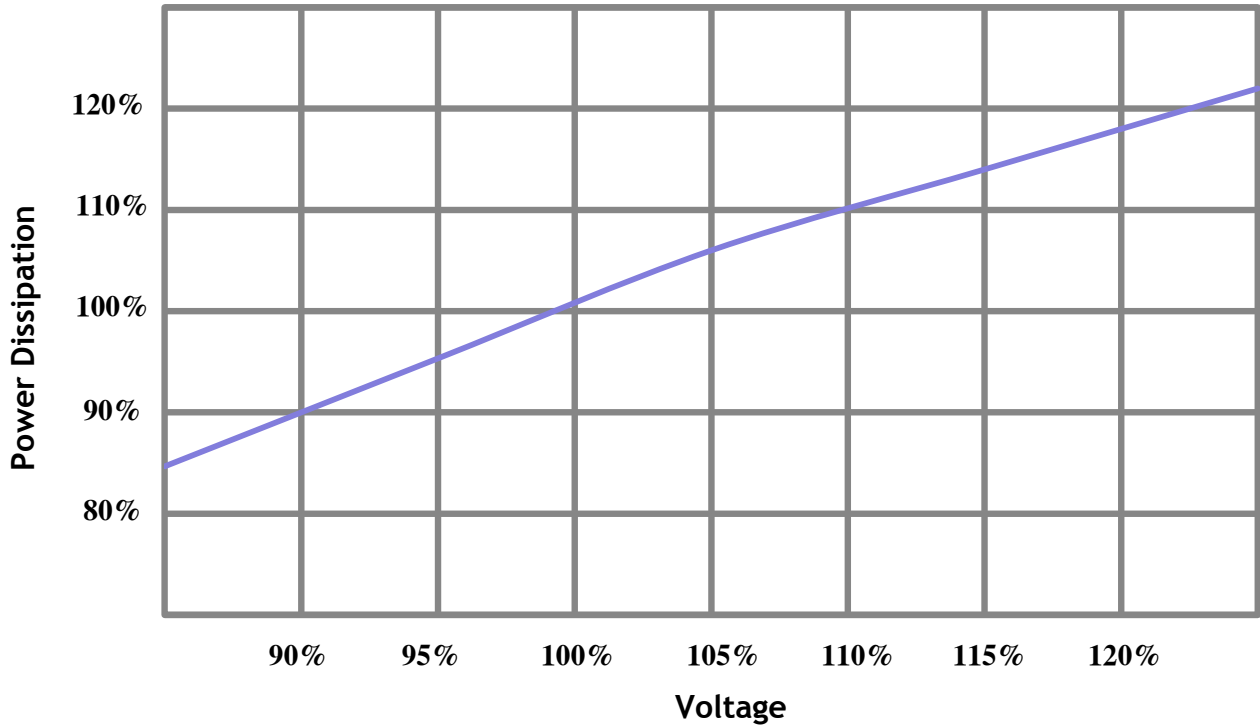

Relative Luminous Flux vs. Voltage

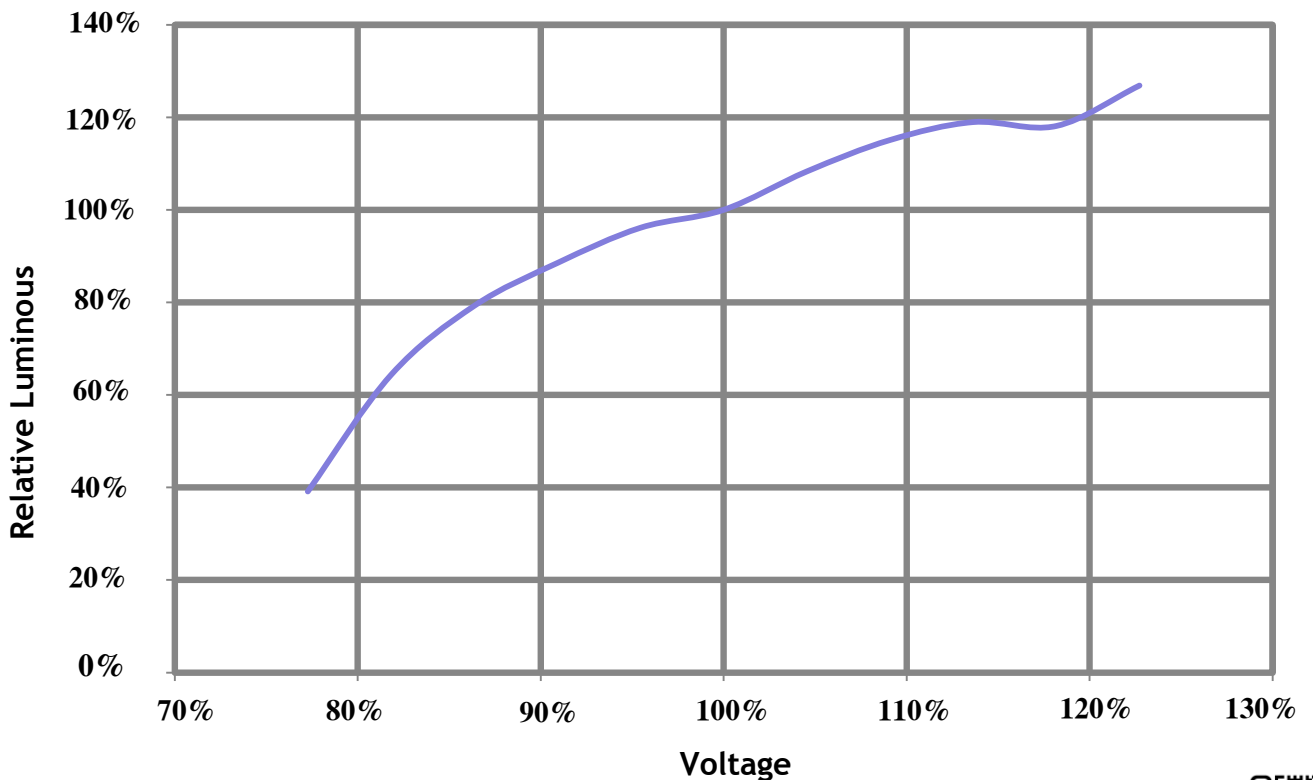

Reliability

No.	Test Item	Test Condition	Remark
1	Temperature Cycle	-40°C-100°C (30 mins / 30 mins)	100 Cycle
2	Low-Temperature Storage	Ta= -40°C	1000 hrs
3	High-Temperature Storage	Ta=105°C	1000 hrs
4	High Temperature High Humidity Life test	Ta=85°C, RH=85%	500 hrs
5	High Temperature Operation Life test	Tc = 55°C / 85°C / 105°C	9000 hrs
6	Super High Temperature Operation Life test	Tc = 105°C	500 hrs
7	ON/OFF Test	3 sec ON, 3 sec OFF	2Million times

Ta : Temperature Ambient
 RH : Relative Humidity
 Tc Point

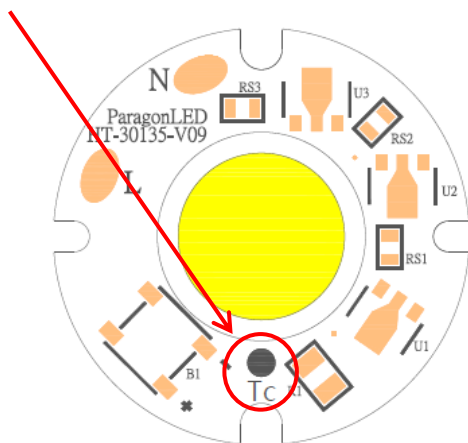

*Schematic diagram



Accessory

Protection ring

Dimensions (ØxH): 36x11.70mm
NO.GPH36135AC Ø2 (with glass)

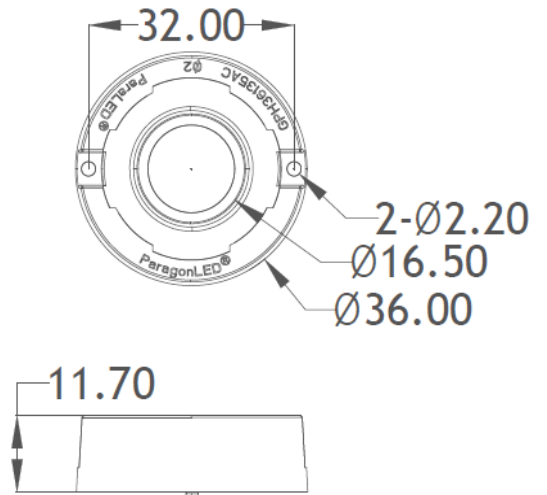
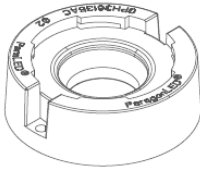

Protection ring

Dimensions (ØxH): 36x11.34mm
NO.LH36135AC Ø2

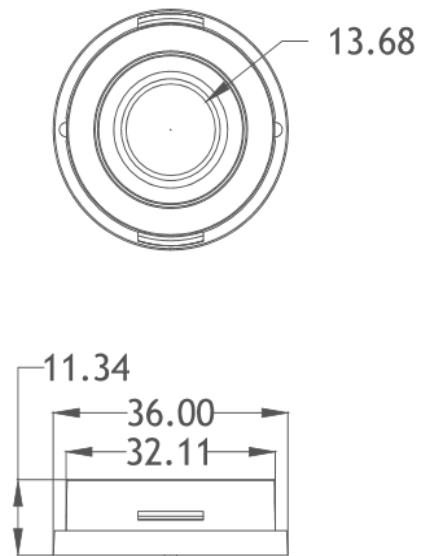
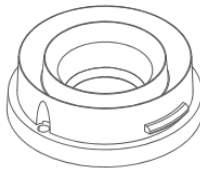

Lens(12°)

Dimensions (ØxH): 50x15.00mm

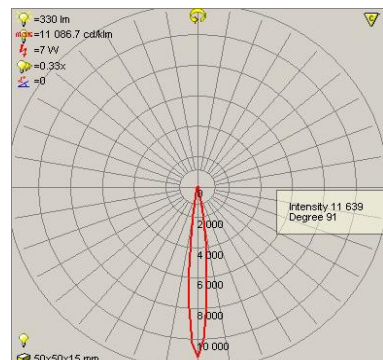
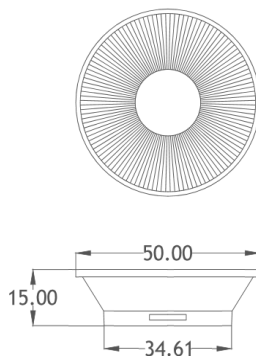
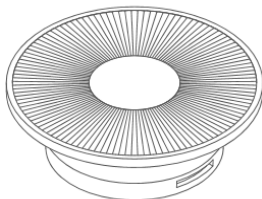

Accessory

Lens(24° & 38°)

Dimensions (ØxH): 35x10.50mm

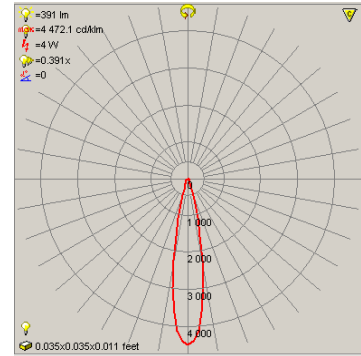
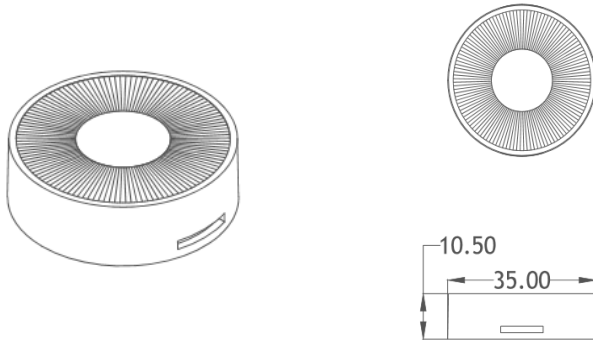

INTENSITY 24°

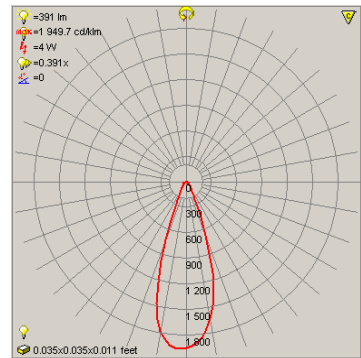

INTENSITY 38°

Bulb diffuser -270°

Dimensions (ØxH): 43.50x37.75mm

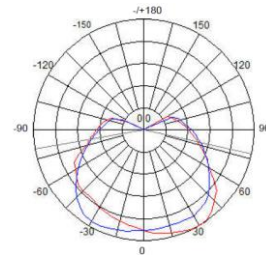
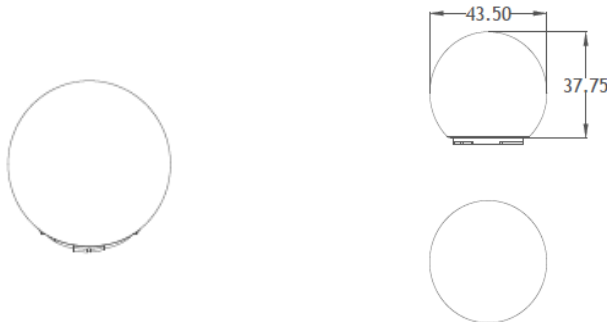

Light guide column-270°

Dimensions (LxH): 19.44x22.73mm

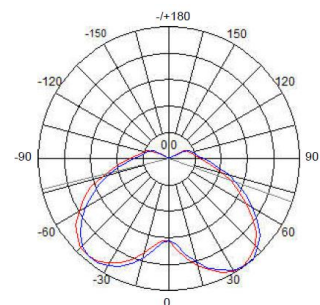
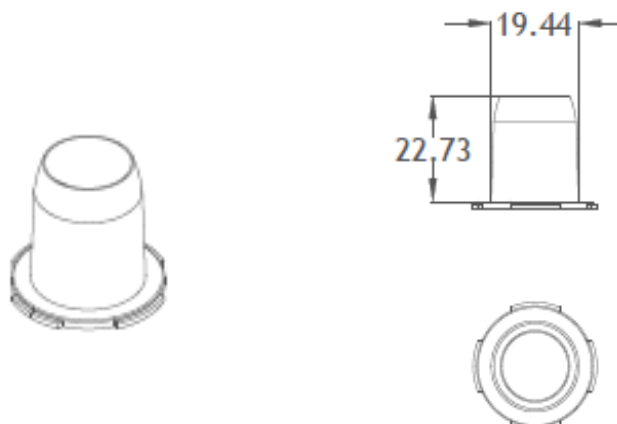

About ParagonLED

Established in 2008, Paragon Semiconductor Lighting Technology Co., Ltd. (ParagonLED®) has been devoted to be a comprehensive supplier of COB LED products. Our product lines include 1.AC LED module 2.Thermal management integration 3.Optical integration 4.AI integration 5.Constant power module series. We have been addressed ourselves to provide good quality products to satisfy clients' needs. Meanwhile we are not in a standstill situation, but keep pursuing progression and innovation.

ParagonLED® pride ourselves on our products, so we have overall arrangement in patent; the total applied patents have been reached 135 items until now. Our manufacturing techniques are also patented by many countries, and we still keep moving forward. Meanwhile we supply good quality products with good performance on CRI and efficiency (lm/w), and strictly controlled CCT.

In ParagonLED®, we do not only supply products, but also provide technical recommendations. What's more, we are more than willing to solve problems with clients together. Hence ParagonLED® and our clients can work together to supply reliable and qualified products to end users!

Devote ourselves to bring more added-value to clients

→Direct Marketing + Localized operation

We have offices in Taiwan, in DongGuan, China, so that we can deal with enquiries directly. Also with agents in many different countries, we and they are able to take care of clients on local basis.

→ Fast delivery

With the manufacturing site located in New Taipei City Linkou, Taiwan, we have different yet convenient transportation ways to reach the world.

→Customized service

Through professional and experienced research and development techniques, we provide customized products that can be tailored to different requirements.

