

Paragon Semiconductor Lighting Technology

PSLT

ParagonLED

Specifications

Product Type : ParaLED-A-042-120V08W3000B-CA

Issued Date : 12/01/2015

Contents

1. General Description

1-1 Naming Rule

1-2 Outline dimensions

2. Electro-optical characteristics

2-1 Absolute Maximum Rating

2-2 Electro-optical characteristics

2-3 Graphs

2-4 Layout

3. Junction Temperature measurement

4. Reliability Test

1.General Description

(1)Naming rule

ParaLED-A-042-120V08W3000B-CA

Product Series type : ParaLED

Dimming Type : Dimmable

Numbers of chips on board : 42

Voltage : 120VAC

Power Dissipation : 8W

Color Temperature : 3000K

Color Rendering : RA80~89

Appearance : Fixing Iron piece(13.5mm) + socket(35mm)

Optical parts : 270 degrees Bulb Diffuser

(2)Outline Dimensions (Unit : mm / Tolerance: 0.2mm)

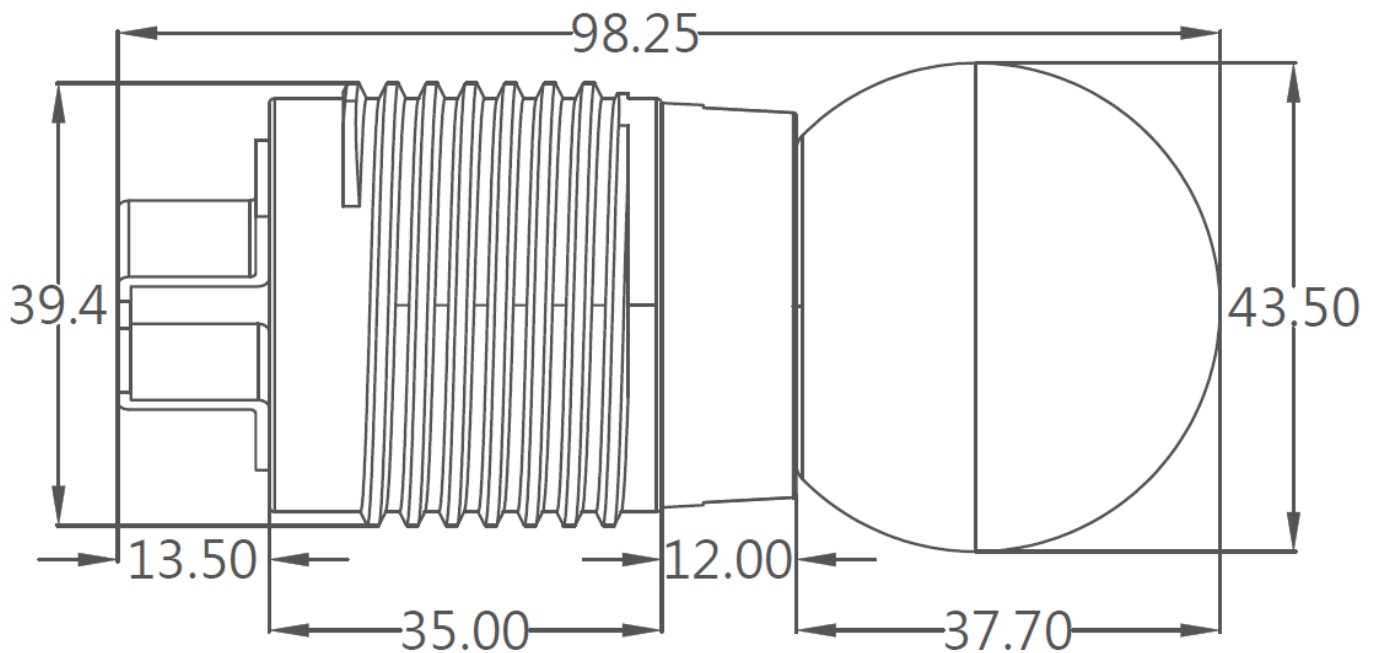

2.Electro-Optical Characteristics

(1)Absolute Maximum Rating

Parameter	Symbol	Value	Unit
Power Dissipation	P_D	8	W
Forward Voltage	V_F	120	V
Operating Temperature	T_{opr}	-40 ~ +105	°C
Storage Temperature	T_{stg}	-40 ~ +105	°C
Power Factor	Pf	>0.95	
THDi		<20%	
Dimming		available	
Assembly process temperature	T_{sol}	<325°C , 5 secs	

(2)Electro-Optical Characteristics

Parameter	Symbol	Condition	Min	Typ	Max	Unit
Forward Voltage	V_F	-	-	120	-	V
Luminous Intensity	Φ_v	$V_F=120V$	-	520	-	Lm
Color rendering	Ra	$V_F=120V$	-	80	-	CRI

Notice: Operating Voltage of product varies from 110V~130V · users must keep the temperature of solder joint point under 105 °C (with suitable heat sink), or may cause Serious luminous decay. We DO NOT guarantee of improper use.

(3) Graphs

Spectrum

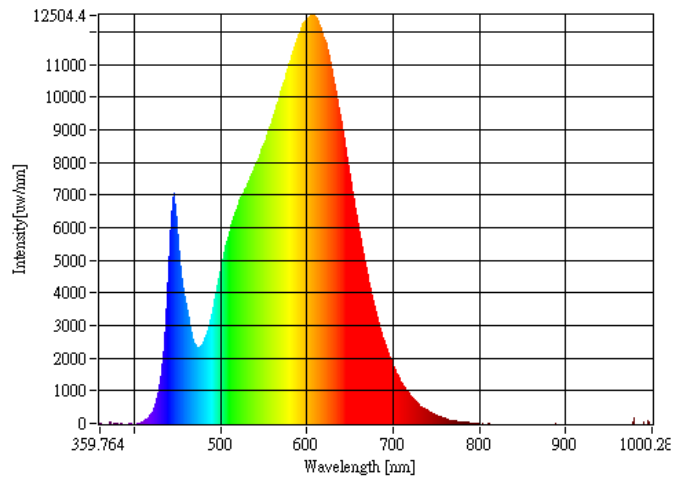

Candle Power Distribution & Cartesian Coordinate

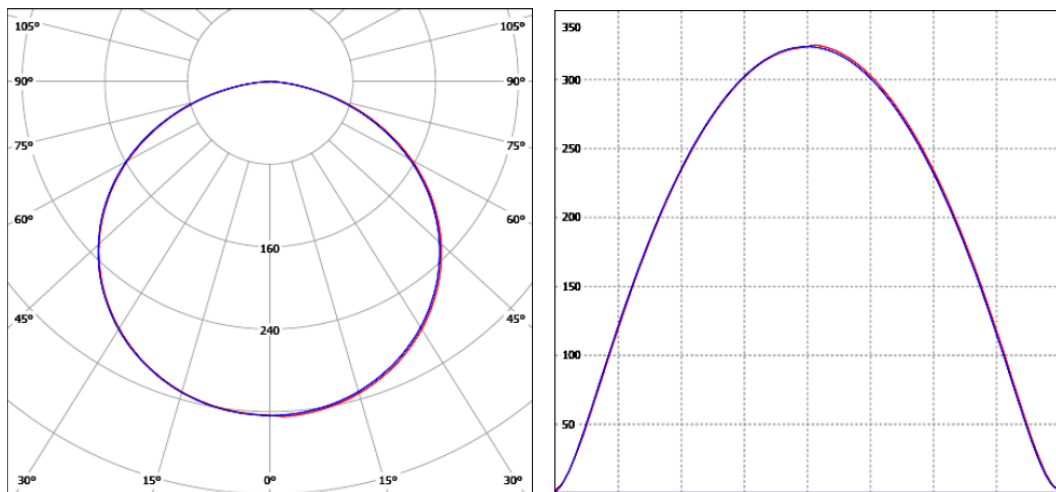

(4) Layout

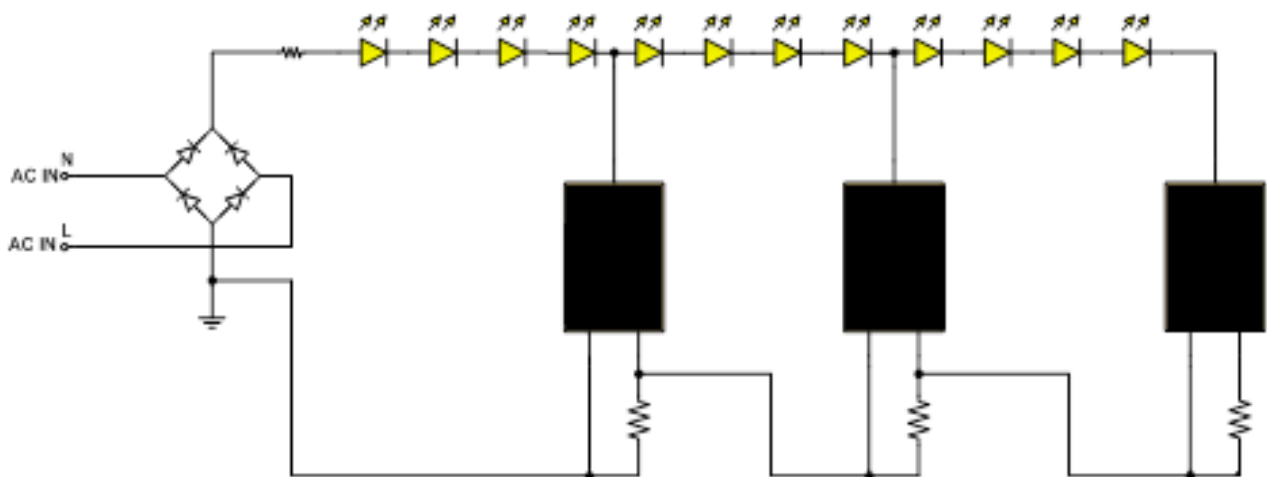

3. Junction Temperature Measurement

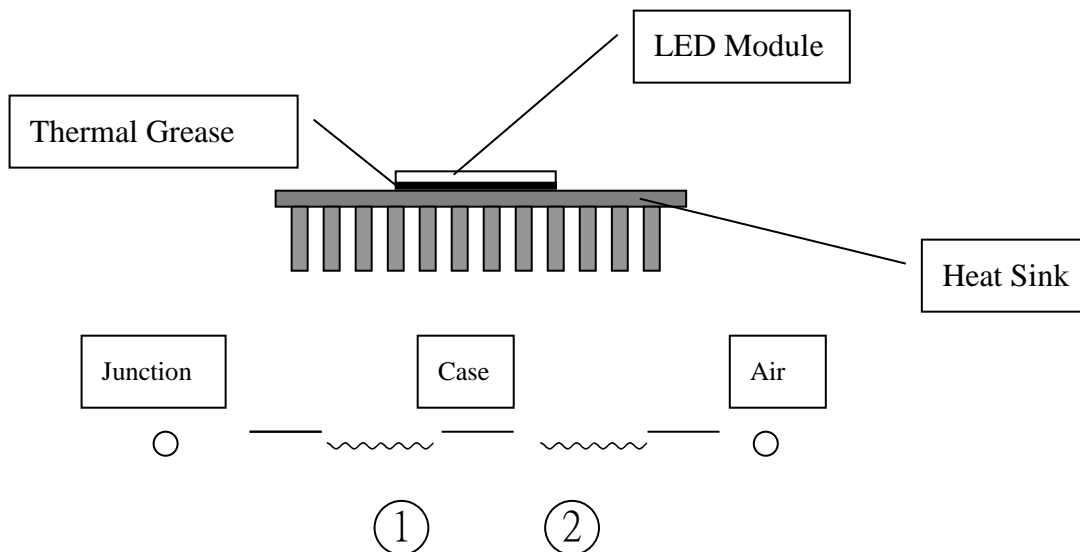

- ① Thermal resistance of Junction to Case without heat sink : $10^{\circ}\text{C}/\text{W}$ [Reference Value]
- ② Thermal resistance of Case to Ambient Air: Depending on what kind of heat sink users choose. In ideal thermal dissipation situation, the thermal resistance is about $1\sim 2^{\circ}\text{C}/\text{W}$.

4. Reliability Test

Test Item	Test Conditions	Number of failed
High Temperature Storage Test	$T_{\text{stg}} = +80^{\circ}\text{C}$, x1,000 hrs	0/20
Low Temperature Storage Test	$T_{\text{stg}} = -40^{\circ}\text{C}$, x1,000 hrs	0/20
Continous Light-on Test	$T_{\text{a}} = 25^{\circ}\text{C}$, RH=65%, x1,000 hrs	0/20
Boiling Test	$T_{\text{a}} = 100^{\circ}\text{C}$, RH=100%, x180mins	0/20
Thermal Cycle Test	-40°C x 30 mins, 80°C x 30 mins, 100 cycles	0/20

Measuring Item	Measuring Condition	Judging Criteria of Failure
Forward Voltage	$I_{\text{F}} = 120\text{V}$	$> 0 \times 1.1$
Total Luminous Flux	$I_{\text{F}} = 120\text{V}$	$< L \times 0.7$