

Paragon Semiconductor Lighting Technology

PSLT

ParagonLED

Specifications

Product Type : CBHT-88-5028-220V-50

Issued Date : 02/01/2015

Paragon Semiconductor Lighting Technology Co., Ltd.
Headquarters: 3F., No.369, Sec. 2, Wenhua 2nd Rd., Linkou Dist., New Taipei City 244, Taiwan (R.O.C.)
TEL: +886-2-2602-1066 FAX: 886-2-2601-0508

Contents

1. General Description

1-1 Naming Rule

1-2 Outline dimensions

2. Electro-optical characteristics

2-1 Absolute Maximum Rating

2-2 Electro-optical characteristics

2-3 Graphs

2-4 Layout

3. Junction Temperature measurement

4. Reliability Test

1. General Description

(1) Naming rule

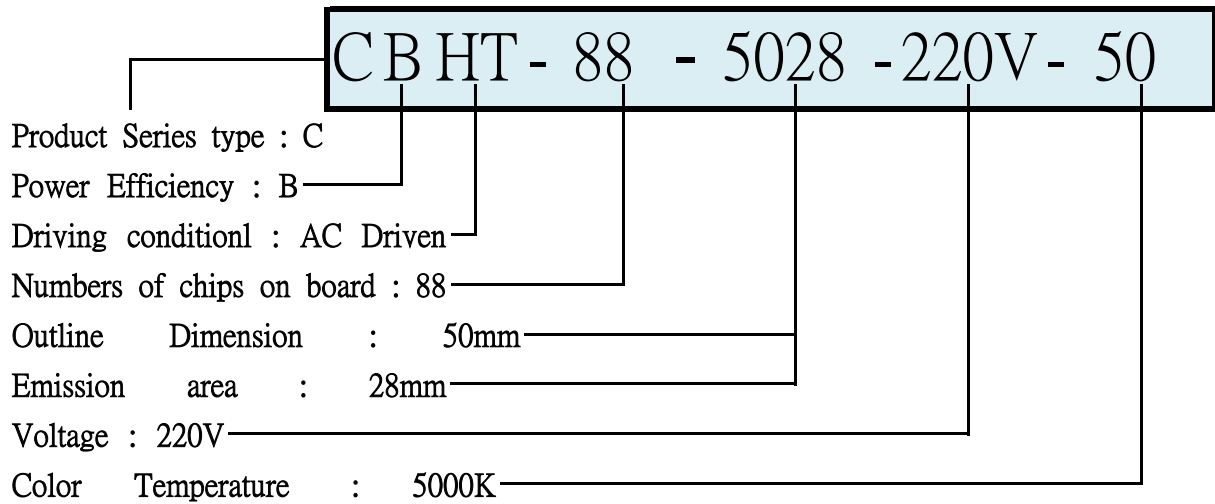

(2) Outline Dimensions (Unit : mm / Tolerance: 0.2mm)

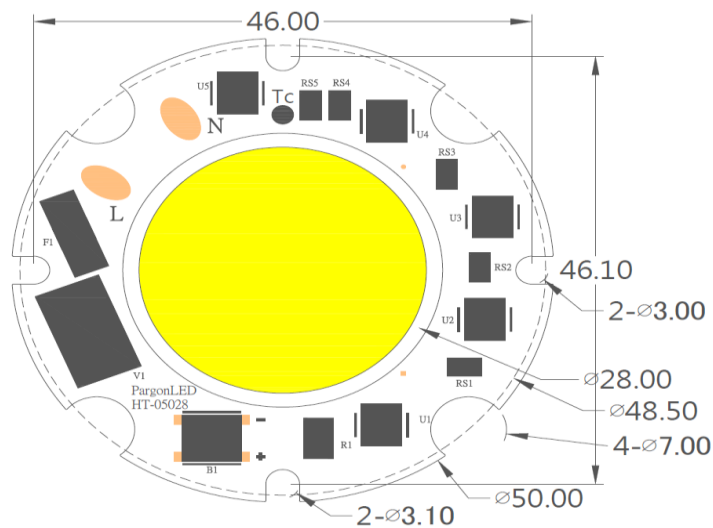

Thickness : 1.0 ± 0.2 mm

2. Electro-Optical Characteristics

(1) Absolute Maximum Rating

Parameter	Symbol	Value	Unit
Power Dissipation	PD	9.5	W
Power Factor	PF	0.95(Min)	
Forward Voltage	VF	210 ~ 240	V
Operating Temperature	Topr	-40 ~ +85	°C
Storage Temperature	Tstg	-40 ~ +100	°C
Assembly process temperature	Tsol	<300°C , 5 secs	

(2) Electro-Optical Characteristics

Parameter	Symbol	Condition	Min	Typ	Max	Unit
Forward Voltage	VF	-	210	220	240	V
Reverse Current	IR	-	-	-	-	μ A
Luminous Intensity	Φ_v	VF=220V	-	1190	-	Lm
Color rendering	Ra	VF=220V	70	-	-	
Total Harmonic Distortion	THD	VF=220V	-	15	-	%

※ support TRIAC DIMMING

Notice: Operating voltage of CBHT-088 product varies from 210V~240V , users must keep the temperature of solder joint point under 85°C (with suitable heat sink), or may cause Serious luminous decay. We DO NOT guarantee of improper use.

(3) Characteristics

Spectrum

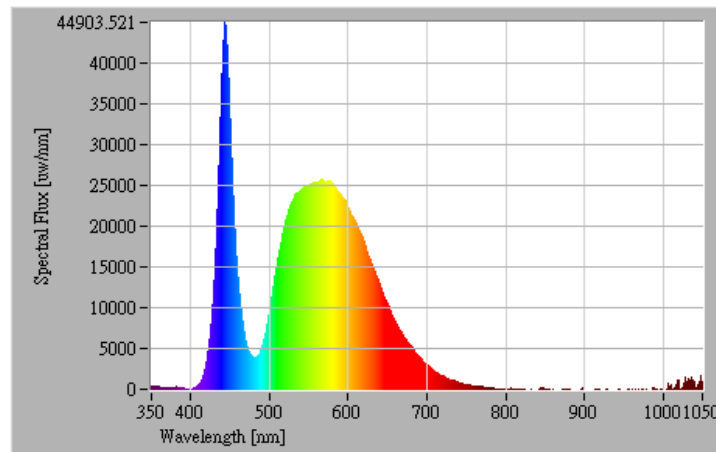

Candle Power Distribution & Cartesian Coordinate

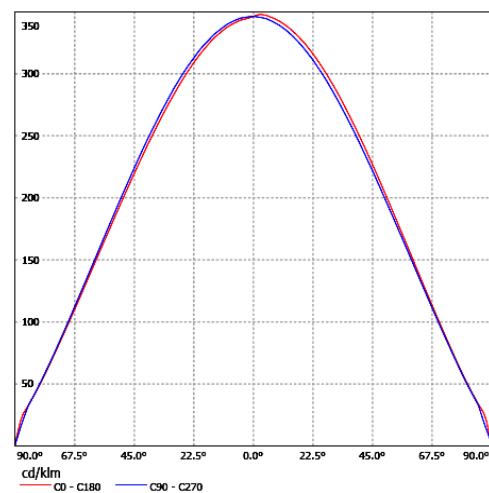
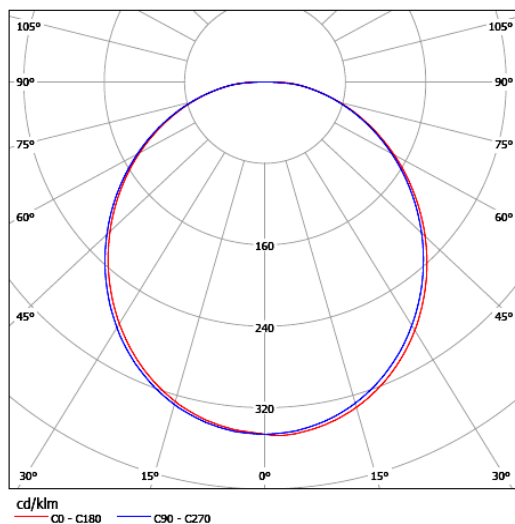

(4) Layout

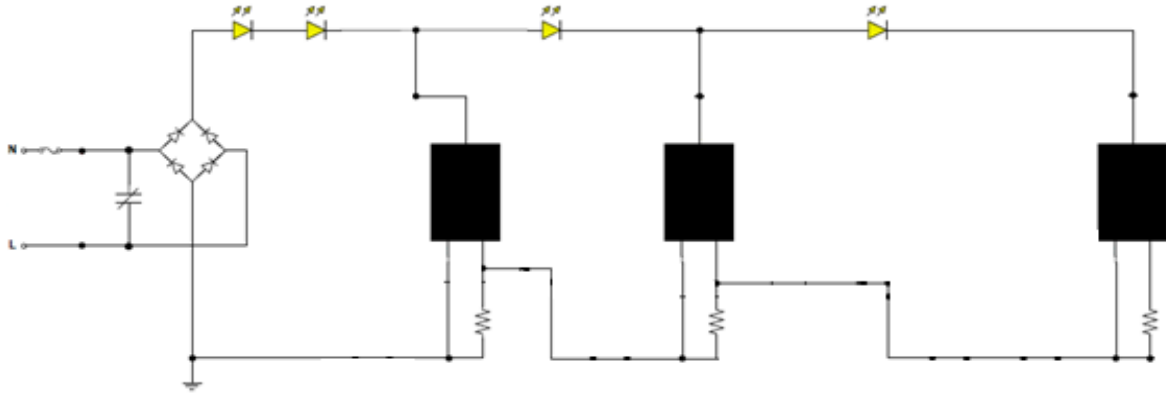

3. Junction Temperature Measurement

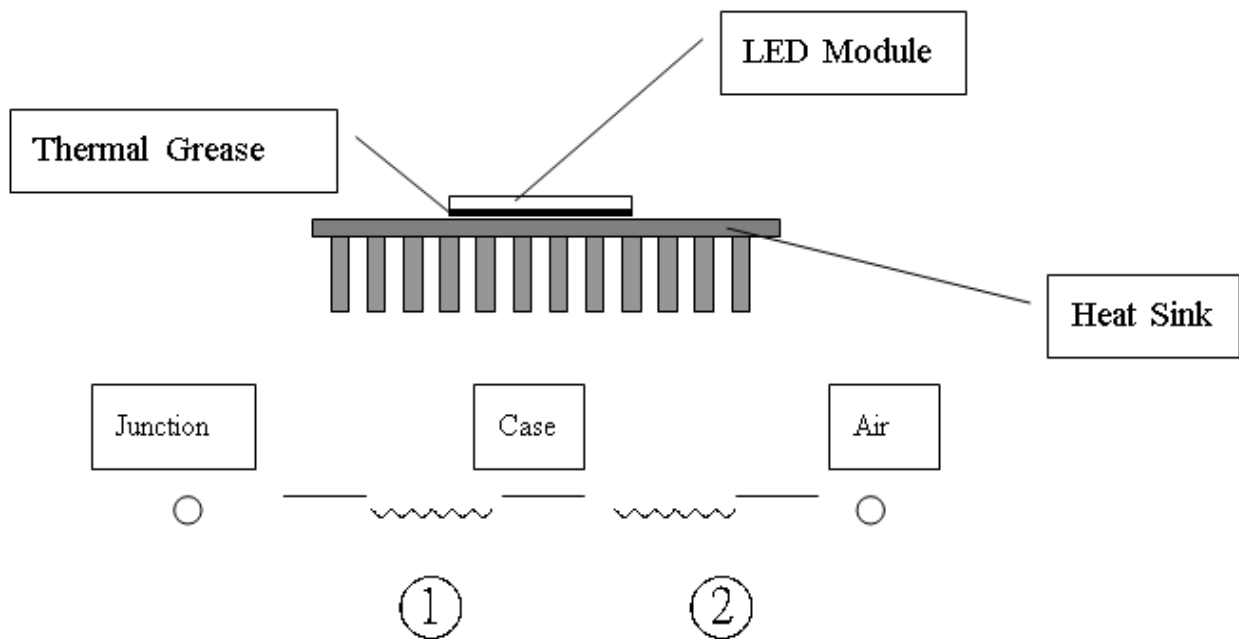

- ① Thermal resistance of Junction to Case without heat sink : $10(^{\circ}\text{C}/\text{W})$ [Reference Value]
- ② Thermal resistance of Case to Ambient Air: Depending on what kind of heat sink users choose. In ideal thermal dissipation situation, the thermal resistance is about $1\sim 2^{\circ}\text{C}/\text{W}$.

4. Reliability Test

Test Item	Test Conditions	Number of failed
High Temperature Storage Test	Tstg= +80°C , x1,000 hrs	0/20
Low Temperature Storage Test	Tstg=-60°C , x1,000 hrs	0/20
Continous Light-on Test	Ta= 25°C , RH=65% , x1,00 hrs	0/20
Boiling Test	Ta=100°C , RH=100% , X180mins	0/20
Thermal Cycle Test	- 40°Cx30mins , 80°Cx30mins , 100cycles	0/20

Measuring Item	Measuring Condition	Judging Criteria of Failure
Forward Voltage	VF=220V	> 0 x 1.1
Total Luminous Flux	VF=220V	< L x 0.85

**WARNING : Please ground lighting fixtures while designing lamps.
If any damage or defect of LED caused without grounding, we do not guarantee of improper use.**